

GCM-403

Operating Manual



Digital Clamp Multimeter

I. Overview

Warning

Please read this manual, the "Safety Information" and warnings carefully before using the meter.

The GCM-403 is a 4000-count AC/DC digital clamp meter with stable performance and a high degree of safety and reliability. It is designed with large-scale integrated circuits and dual integrating A/D converters as its core. It has overload protection for all ranges and a novel design, which makes it a superb tool for electricians. The meter can measure AC/DC voltage, AC/DC current, resistance, diodes, continuity, capacitance, frequency and temperature.

II. Unpacking Inspection

Please open the package box and take the instrument out. Please check if the following items are missing or damaged.

1. Operating Manual	1 pc
2. Test Probes	1 pair
3. Temperature probe	1 pc

Please contact your supplier straight away if any item is missing or damaged.

III. Safety Information

The instrument is designed and manufactured in compliance with GB4793, IEC61010-1 and IEC 1010-2-032: Double Insulation, Overvoltage CAT II 600V & CAT III 300V and Pollution Degree 2. A Warning identifies conditions and actions that may pose hazards to the user, or cause damage to the meter or equipment under test. Please pay attention to **Warnings** and use the meter as specified as below, otherwise you may impair the protection offered by the clamp meter.

1. Please inspect the clamp meter and test leads before use to avoid damage or abnormal use. Please do not use the clamp meter again if the test leads or case insulation is damaged, the LCD display has failed or the clamp meter cannot operate normally.
2. It is strictly prohibited to use the clamp meter without covering the rear cover and/or the battery cell to avoid electric shock.
3. Fingers cannot exceed past the probe's finger guard during measurement. To avoid electric shock, do not touch naked electric wires, connectors, exposed inputs or circuits during measurement.
4. The measurement function dial must be in the correct position before measurement. Do not change ranges during measurement to avoid damaging the clamp meter.
5. Do not exert more than 600V between the clamp meter terminal and ground to avoid electric shock or damage to the clamp meter.
6. To avoid electric shock, operate the instrument carefully under DC 60V or AC 30V.
7. Do not measure voltage or current which is greater than the allowable input levels. Be sure to set the function range switch to the highest range possible if the magnitude of the measured value is unknown. Be sure to turn off the circuit

power and discharge all capacitors before measuring resistors, diodes or circuits. Disconnect the probes and the measured circuit, then remove the probes from clamp meter inputs and lastly turn off the power after measurement.

8. Replace the battery when "EOL" shows on the LCD to ensure the measuring accuracy. Remove the battery if the clamp meter has not been used for a long time.
9. Please do not alter the internal wiring of the clamp meter randomly to avoid instrument damage and jeopardise safety.
10. Do not store or use the clamp meter in an environment with high-temperature, high-humidity, flammables, explosives or strong current magnetic fields.
11. Clean the instrument case with a soft cloth and neutral detergent during maintenance. Do not use abrasives or solvents to avoid case corrosion which may cause damage to the clamp meter or cause personal injury.

IV. Electrical Symbols

	Double Insulated		Grounding
	AC		DC
	Diode		Low battery Indication
	Warning prompt		Buzzing ON/OFF
	AC or DC		
	To meet European Union standard.		

V. The Meter Structure (See Figure 1)

1. Input end;
2. LCD digit display;
3. Functions key: To select basic functions;
4. Measurement Function dial: The grey function icons are the initial functions; The blue function icons are selected after pressing the blue SELECT key;
5. Clamp head trigger: Press the trigger to open the clamp head. The clamp head will close again if the trigger is released;
6. Hand protection: It prevents users from touching any dangerous areas.
7. Clamp head: It is a device to measure AC/DC current and converts the current to voltage. A single conductor of the measured current must pass perpendicularly through center of the clamp head.

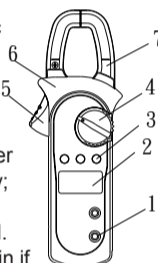

Figure 1

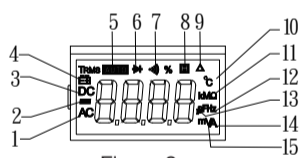

Figure 2

VI. Display Symbols(See Figure 2)

1. Indicator for AC Measurement;
2. Indicates negative polarity;
3. Indicator for DC Measurement;
4. Low Battery Indicator;
5. Auto-Ranging Mode;
6. Indicator for Diode Test;
7. Indicator for Continuity Test;
8. Data Hold is Active;
9. Indicator for Relative Measurement;
10. Temperature Unit (°C);
11. Resistance Units (Ω, kΩ and MΩ);
12. Frequency Units (Hz);
13. Capacitance Units (nF and μF);
14. Current Unit (A);
15. Voltage Units (mV and V);

VII. Key Functions and Automatic Shutdown

1. HOLD

This function maintains the displayed reading on the LCD display. The displayed value will be locked on the display by pressing the key once. It can be pressed again to release locking state and return to the common measurement state.

2. REL

Press down the key to use current reading as the reference value and reset the display to "0". This reference value is subtracted every time from measuring results until you press the key again to exit the mode.

Note: When the REL function is turned on in ACV, Ω or DCV measurement modes, the meter locks the range to the current measurement range. Therefore, after turning off the REL function, you need to push the SELECT key or set the function dial to another position to manually restore the auto-range function.

When the displayed reading shows "OL" in Ω, diode or continuity measurement modes, the REL function may not be turned on or off. To switch on or off the REL function with these functions, first short the test leads or connect the test leads to a DUT so as to prevent the "OL" state occurring.

3. SELECT

Used to switch between V_{AC} , V_{DC} , Ω , \rightarrow , \rightarrow , \rightarrow , \rightarrow , \rightarrow . Note: Automatic shutdown function will be cancelled if the SELECT key is pressed to wake up the meter from the sleep mode.

4. Automatic Shutdown

The clamp meter will "power off automatically" (under sleep mode) to save electric energy if the function key or the measurement function dial are not used within 15 minutes during measurement. The clamp meter will start up automatically (under working mode) by rotating the measurement function dial under automatic shutdown mode. (Please refer to Item 6 for valid key function operations.)

Note: The automatic shutdown function will be cancelled by pressing the SELECT key to wake-up the unit from the sleep mode.

5. Buzzer

The buzzer will beep when any effective function key is pressed under any measurement range. It will not beep if the key is invalid. The buzzer will issue 5 warning beeps continuously for about 1 minute before automatic shutdown. It will also issue a long beep before power off.

6. Valid Key Functions

Not all functions are valid under any range. As indicated below, the corresponding functions or to wake up the meter can be achieved only when the keys are valid.

Key	SELECT	REL	HOLD
V_{AC}	●	●	●
Ω , \rightarrow , \rightarrow , \rightarrow , \rightarrow	●	●	●
Hz	N/A	N/A	●
°C	N/A	●	●
40A \rightarrow	●	●	●
600A \rightarrow	●	●	●

VIII. Measurement Instructions

1. DC voltage measurement (V_{DC}) (See Figure 3)

Warning: The clamp meter cannot be used with conductors that exceed AC/DC 600V.

•Set the dial: Turn the measurement function dial to " V_{DC} ".

•Select key functions: The clamp meter defaults to DC Voltage and auto-ranging mode. Press REL Δ to access the relative mode.

•Connect to the load.
•Disconnect the probe from the measured circuit then remove the probe from the clamp inputs after all measurement operations.

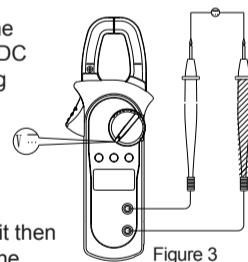

Figure 3

2. AC voltage measurement (V_{AC}) (See Figure 4)

Warning: The clamp meter cannot be used for conductors which exceed AC/DC 600V.

•Set the dial: Turn the measurement function dial to " V_{AC} ".

•To select key functions: Press the SELECT button to select AC voltage mode. It defaults to auto-ranging. Press REL Δ to access relative mode.

•Connect to the load.
•Disconnect the probe from the measured circuit then remove the probe from the clamp inputs after all measurement operations.

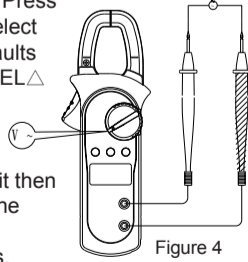

Figure 4

Resistance measurement (Ω) (See Figure 5)

Warning: Be sure to turn off circuit power and discharge residual charge from all capacitors before connecting a load.

•Set the dial: Turn the measurement function dial to " Ω ".

•To select key functions: The clamp meter defaults to Ω and auto-ranging mode.

Press REL Δ to access the relative mode.

•Connect the load.

•For best measurement results separate the resistive element from the circuit. After all measurement operations, disconnect the probe and the measured circuit and then remove the probe from input end.

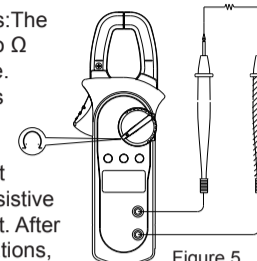

Figure 5

4. Diode measurement (\rightarrow) (See Figure 6)

Warning: Be sure to turn off circuit power and discharge residual charge from all capacitors before connecting a load.

•Set the dial. Turn the measurement function dial to " \rightarrow ".

•Select functions: Select diode by pressing the SELECT key;

•Connect the load.

•For best measurement results separate the diode from the circuit.

•After all measurement operations, disconnect the probe from the measured circuit then remove the probe from the clamp inputs.

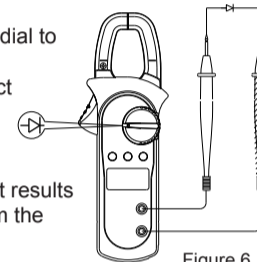

Figure 6

5. Continuity Test (\rightarrow) (See Figure 7)

Warning: Be sure to turn off circuit power and discharge residual charge from all capacitors before connecting the load.

•Set the dial. Turn the measurement function dial to " \rightarrow ".

•Select continuity by pressing the SELECT key.

•Connect to the load.

•The Buzzer will beep if the measured resistance is less than 10Ω. It will not beep if the measured resistance exceeds 10Ω.

•After all measurement operations, disconnect the probe from the measured circuit then remove the probe from the clamp inputs.

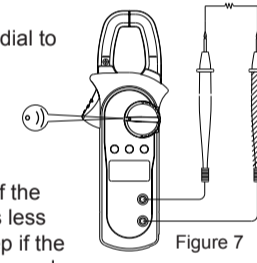

Figure 7

6. Capacitance measurement (\rightarrow) (See Figure 8)

Warning: Be sure to turn off circuit power and discharge residual charge from all capacitors before connecting the load.

•Set the dial. Turn the measurement function dial to " \rightarrow ".

•Select capacitance by pressing the SELECT key.

•Connect the load.

Measurement notice:

1) Be sure to reset the unit by pressing the REL Δ key before measurement.

2) The instrument reading normally will be delayed by about 30 seconds when measuring large capacitances.

•After all measurement operations, disconnect the probe from the measured circuit then remove the probe from the clamp inputs.

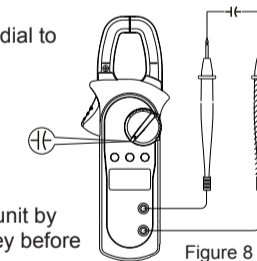

Figure 8

7. Frequency measurement (Hz) (See Figure 9)

Warning: The clamp meter cannot be used for conductors which exceed AC/DC 600V.

•Set the dial. Turn the measurement function dial to "Hz".

•Connect to the load.

•After all measurement operations, disconnect the probe from the measured circuit then remove the probe from the clamp inputs.

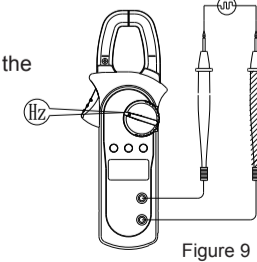

Figure 9

8. Temperature measurement (°C) (See Figure 10)

•Set the dial. Turn the measurement function dial to "°C".

•Connect the load
1) The LCD will display "OL" if the temperature sensor is not inserted. The clamp meter will display the current indoor temperature after you insert the temperature sensor.

2) The protection for the temperature range is a 1KΩ resistor(R59). To avoid damage, any conductor with a voltage present shouldn't be inserted into the input jack.

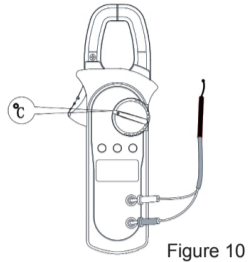

Figure 10

9. DC current measurement (A_{DC}) (See Figure 11)

•Set the dial. Turn the measurement function dial to "40A" or "600A".

•Select functions. The meter defaults to DC Current Mode.

•Connect to the load.

Please do not release the trigger suddenly. As a sensitive device, the Hall element is sensitive to heat and mechanical stress to different extents in addition to magnetic sensitivity. Collisions will cause short-term reading variations.

Open the clamp head by pressing the trigger, then place the measured conductor into the clamp head and release the trigger slowly until the clamp is completely closed. Check to make sure that the measured conductor is in the middle of the clamp head.

Additional errors may be caused if you do not place the conductor in the middle of the clamp head. The clamp meter should only be used to measure a single current conductor at a time. A measurement reading error may be caused if measuring two or more current conductors at the same time.

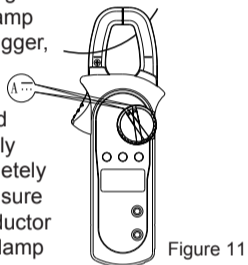

Figure 11

10. AC current measurement (A_{AC}) (See Figure 12)

•Set the dial. Turn the measurement function dial to "40A" or "600A".

•Select functions. Press the SELECT key for AC current measurement.

•Connect to the load.

Please do not release the trigger suddenly. As a sensitive device, the Hall element is sensitive to heat and mechanical stress to different extents in addition to magnetic sensitivity. Collisions will cause short-term reading variations. Open the clamp head by pressing the trigger. Then place the measured conductor into the clamp head and release the trigger slowly until the clamp is completely closed. Check to make sure that the measured conductor is in the middle of the clamp head.

Additional errors may be caused if you do not place the conductor in the middle of the clamp head. The clamp meter should only be used to measure a single current conductor at a time.

A measurement reading error may be caused if measuring two or more current conductors at the same time.

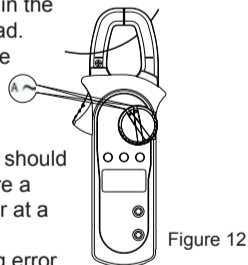

Figure 12

IX. Technical Indicators

1. General specification

LCD display: 4000 counts;
Polarity display: Automatic display;
Overload display: Displays "OL" or "-OL",
Low battery indication: shows that the battery voltage is less than the required working voltage.
Sampling rate: 3 times/second;
Sensor category: Hall affect sensor for DC/AC measurement;
Error of testing position: ±1.0% of additional reading error may be caused if the measured source is not placed in the center of the clamp head during current measurement;
Shock-resistant: Passed 1m drop test;
Max.clamp opening: 28mm diameter;
Max. tested conductor: 26mm diameter;
Influence of electromagnetic fields: If the device is used near a electromagnetic field the display may be unstable or produce incorrect readings;

2. Environment limitation

Indoor use
Altitude height: 2,000m
Safety rules: ICE 1010-1 CAT.II 600V CAT.III300V
Pollution degree: 2
Operation temperature & humidity: 0°C to 30°C (not more than 80%R.H.)
30°C to 40°C (not more than 75%R.H.)
40°C to 50°C (not more than 45%R.H.)
Storage temperature & humidity: -20°C to +60°C (not more than 80%R.H.)

3. Electrical specification

Accuracy: ±(a% readings + b digits)
Calibration period: 1 year
Ambient temperature: 23°C ± 5°C
Ambient humidity: Not more than 80% R.H.
Temperature coefficient: 0.1*precision/1°C

(1) DC voltage (V_{DC})

Range	Resolution	Accuracy	Overload protection
400.0mV	0.1mV	±(0.8%+3)	600V DC/AC
4.000V	1mV	±(0.8%+1)	
40.00V	10mV		
400.0V	100mV		
600V	1V		

Input impedance: 10M Ω

(2) AC voltage (V_{AC})

Range	Resolution	Accuracy	Overload protection
4.000V	1mV	±(1%+5)	600V DC/AC
40.00V	10mV		
400.0V	100mV		
600V	1V		

Input impedance: 10MΩ //not less than 100pF
Frequency response: 40Hz~400Hz
AC conversion type:
AVG response, RMS value for sinewave input.

(3) Resistance (Ω)

Range	Resolution	Accuracy	Overload protection
400.0Ω	100mΩ	±(1.2%+2)	600Vp
4.000KΩ	1Ω	±(1%+2)	
40.00KΩ	10Ω		
400.0KΩ	100Ω		
4.000MΩ	1KΩ		
40.00MΩ	10KΩ		

(4) Diode test (→|←)

Range	Resolution	Accuracy	Overload protection
	1mV	Displays approximate forward bias voltage. (open circuit voltage is about 1.48V.)	600Vp

(5) Continuity test (•|•)

Range	Resolution	Accuracy	Overload protection
	0.1Ω	The buzzer will sound if the resistance is less than or equal to 10 Ω (Open circuit V is about 0.45V)	600Vp

Note: 0 ~ 10Ω is the minimum range specified for continuity, and as such the buzzer may also beep with resistances slightly higher than 10Ω.

(6) Capacitance (—|—)

Range	Resolution	Accuracy	Overload protection
40nF	0.01nF	±(4.0%+3)	600Vp
400nF	0.1nF		
4μF	0.001μF		
40μF	0.01μF		
100μF	0.1μF		

To measure under RELATIVE measurement mode;

(7) Frequency (Hz)

Range	Resolution	Accuracy	Overload protection
10Hz	0.001Hz	±(0.5%+3)	600Vp
100Hz	0.01Hz		
1kHz	0.1Hz		
10kHz	1Hz		
100kHz	10Hz		
1MHz	100Hz		
10MHz	1kHz		

Sensitivity: ≥300mV rms if ≤100kHz;
≥600mV rms if >100kHz;
≥800mV rms if >1MHz;

(8) Temperature (°C)

Range	Accuracy	Overload protection
-40°C~1,000°C	-40°C~0°C ±(8%+5) 0°C~400°C ±(2.5%+3) 400°C~1,000°C ±(3.0%+3)	Plug-in resistance of 1KΩ

Note:

- 1) There is no voltage protection for the temperature ranges. Do not insert a live conductor into the input jack to avoid burnout of the 1k resistor;
- 2) K type thermocouple (Ni-Cr~Ni-Si) is only suitable for temperature measurement of less than 230°C. A rod-type temperature sensor should be used for temperature measurement of more than 230°C.

(9) DC current (A_{DC})

Range	Resolution	Accuracy	Overload protection
40.00A	0.01A	±(2%+5)	600A DC/AC
600A	1A		

Note:

The current measurement function must be operated between 0°C and 40°C. Current direction is from bottom to top for positive readings during DC current measurement. (As shown in Figure 11, the panel is on the top and the bottom cover is on the bottom.) Please do not release the trigger suddenly. As a sensitive device, the Hall element is sensitive to heat and mechanical stress to different extents in addition to magnetic sensitivity. Collisions will cause short-term reading variations. Better A_{DC} measurements can be performed by following these operation methods:

- ① Press the trigger and open the clamp head to put the measured conductor into the clamp head. Then release the trigger slowly until the clamp head is closed completely. Check to make sure that the measured conductor is in the middle of the clamp head. An additional reading error of ±1.0% may be caused if the conductor is not placed in the middle of clamp head;
- ② Remove the clamp head away from the current conductor;
- ③ Press the REL key to reset the display;
- ④ Repeat step ①;
- ⑤ Gain better readings by using the above measurement steps;

(10) AC current (A_{AC})

Range	Resolution	Accuracy	Frequency response	Overload protection
40.00A	0.01A	±(2.5%+8)	50Hz~60Hz	600A DC/AC
600A	1A	±(2.5%+5)		

Note:

Current measurement must be performed between 0°C and 40°C. Frequency response: 50Hz~60Hz; Unstable or incorrect inductive readings with less than 10 digits may be displayed in the AC current range and it will not influence the measurement result. Do not release the trigger suddenly. As a sensitive device, the Hall element is sensitive to heat and mechanical stress to different extents in addition to magnetic sensitivity. Collisions will cause short-term reading variations.

AC conversion type: The displayed reading is the calculated RMS value of a sinewave input.
AVG response: RMS value for sinewave input.

X. Maintenance (See Figure 13)

Warning: Please remove any test leads before opening the bottom cover to avoid electric shock.

1. General maintenance.

A. The clamp meter should only be repaired and serviced by qualified professional repair personnel or a GW Instek service center.

B. Clean the case periodically with a dry cloth. Do not use detergent with abrasives or solvents.

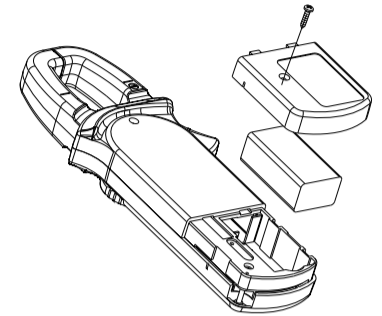

Figure 13

2: Battery installation or replacement of the 16F22 9V battery. Install the battery using the following method:

- a. Please remove any test leads from the input terminals during shutdown.
- b. Place the unit front panel face down. Loosen the screws on the battery cover. Remove the battery cover.
- c. Remove the old battery from the battery compartment and install the new battery. Make sure the battery polarity is correct when installing the new battery.
- d. Use the same battery type. Do not install the battery improperly.
- e. Install the battery cover and tighten the screws after installing the new battery.

This manual contains proprietary information, which is protected by copyright. All rights are reserved. No part of this manual may be photocopied, reproduced or translated to another language without prior written consent of Good Will company. The information in this manual was correct at the time of printing. However, Good Will continues to improve products and reserves the rights to change specification, equipment, and maintenance procedures at any time without notice.

Good Will Instrument Co., Ltd.
No. 7-1, Jhongsing Rd., Tucheng Dist., New Taipei City 236, Taiwan.